



# TE-4K-MD

## DIMENSIONAL SCHEMATIC, PERFORMANCE AND PARTS LIST

### DIMENSIONS mm

not to scale  
specifications are subject to change

Inlet: 1" BSP.F  
Outlet: 1/2" BSP.M

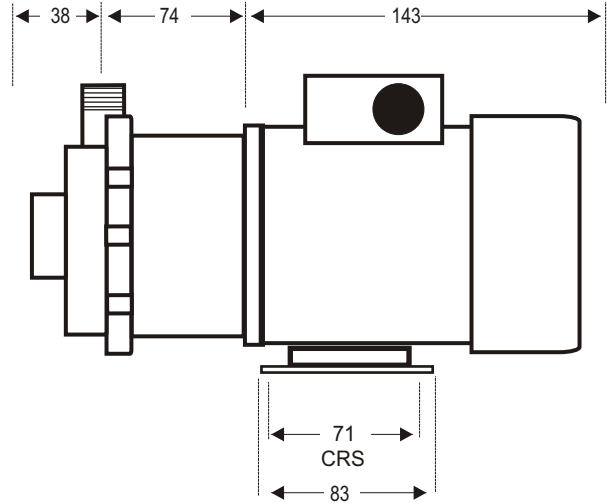
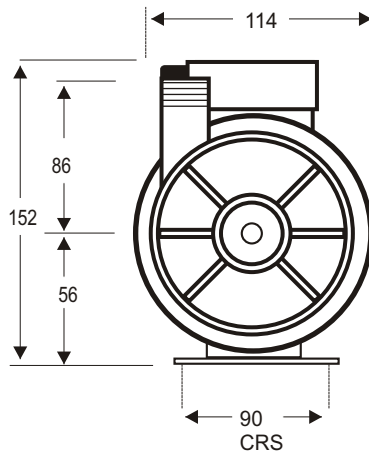

Details may change depending upon the motor specified

### PARTS LIST

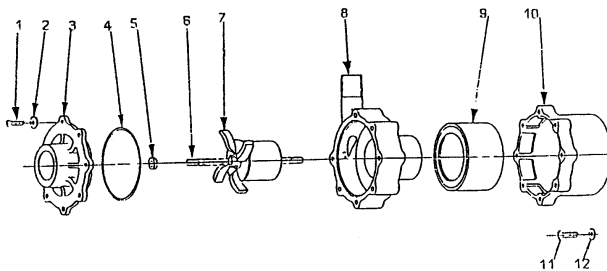

ITEM	DESCRIPTION	NOS	CODE
1	HOUSING SCREWS ST/STEEL	7	0150-100-UK
2	HOUSING WASHERS ST/STEEL	7	0150-200-UK
3	PUMP COVER KYNAR (BSP)	1	0150-124-10
4	'O' RING VITON	1	0135-023-UK
5	CERAMIC THRUST WASHER	1	0130-028-UK
6	CERAMIC SPINDLE	1	0130-024-UK
7	IMPELLER ASSY KYNAR	1	0145-039-02
8	PUMP HOUSING KYNAR	1	0150-123-01
9	DRIVE MAGNET ASSY 9mm	1	0750-193-01
10	MOTOR BRACKET	1	0001-050-UK
11	BRACKET FIXING SCREWS	4	0130-100-UK
12	BRACKET FIXING WASHERS	4	0135-200-UK
13	WET END ASSY ITEMS 1-8		0040-333-01
14	PUMP HEAD ASSY ITEMS 1-12		P040-333-02

### PERFORMANCE

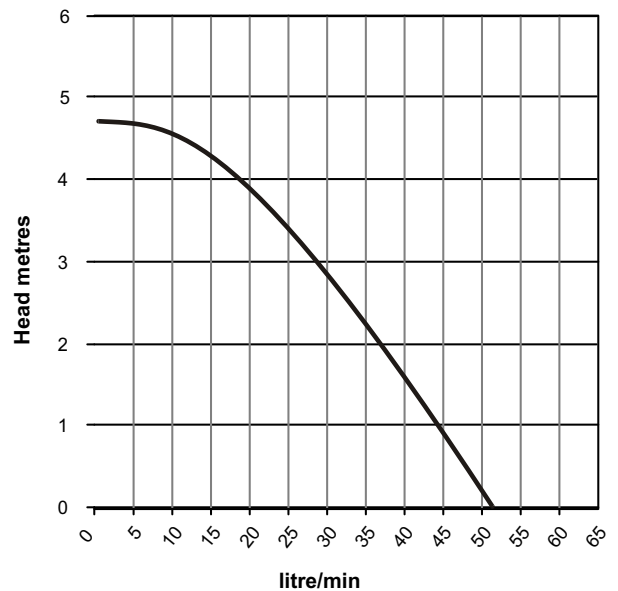

Tests obtained with water 1.0 SG

— 50 hz 2900 rpm