



MS 20/13

DIMENSIONAL SCHEMATIC, PERFORMANCE AND PARTS LIST

DIMENSIONS mm

not to scale
specifications are subject to change

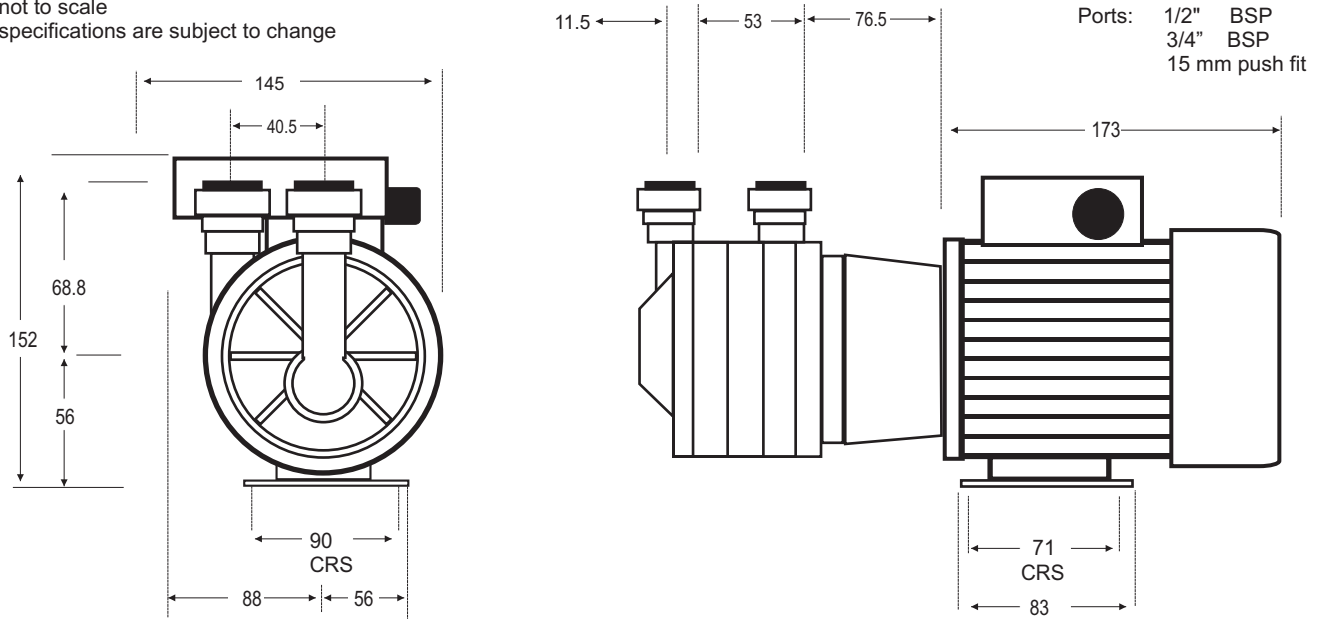

Details may change depending upon the motor specified

PARTS LIST

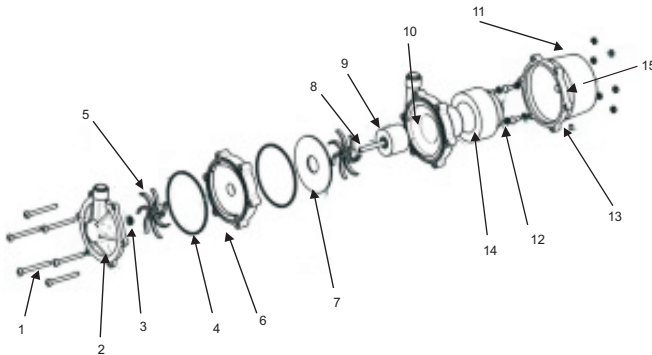

MS 20/13

1	M5 x 70 Pozi Pan Screw St Stl Set	6	5020-212-50
2	MS Front Cover PP JG	1	5020-110-01
	MS Front Cover PP 1/2" NPTM	1	5020-111-01
	MS Front Cover PP 3/4" BSPM	1	5020-112-01
3	Washer Thrust Ceramic	1	0130-028-UK
4	Impeller PPS	3	5021-130-08N
5	O Ring Viton	3	5020-122-31
6	Stage Housing PP	2	5020-150-01
7	Backing Plate	2	5020-160-13
8	Spindle Ceramic	1	5020-232-70
9	Impeller magnet	1	5021-191-22
10	Pump Housing PP JG	1	5020-140-01
	Pump Housing PP 1/2"NPTM	1	5020-141-01
	Pump Housing PP 3/4"BSPM	1	5020-142-01
11	Full Nut M5 St Stl Set	6	5021-180-50
12	Screw M5 x 12 Pozi Pan St Stl Set	4	5021-2212-50
13	Washer M5 Shakeproof St Stl Set	4	0135-200-UK
14	Drive Magnet Assm	1	5021-203-11
15	Bracket PP	1	5020-170-01
16	Socket Set Screw M5x6 St Stl	1	5021-500-56

PERFORMANCE

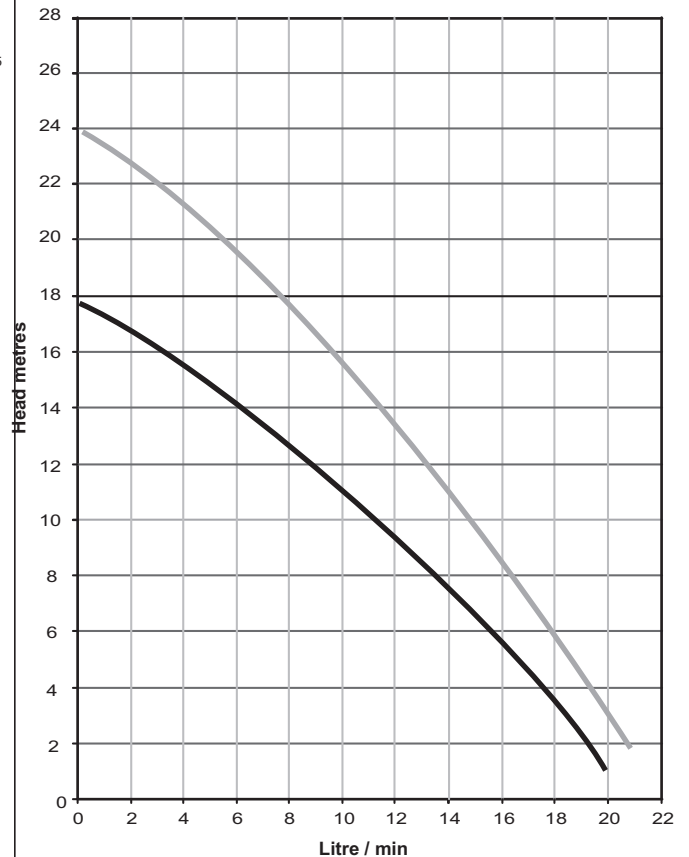

Tests obtained with water 1.0 SG

— 50 hz 2900 rpm
— 60 hz 3400 rpm